

UL LISTED - SOLID LID - HIGH UPLIFT

SPECIFICATIONS

- Fully Welded & Assembled Curb 16 GA G90 Steel or 0.100" Aluminum
- 4" x 4" x 3/16" Galvanized Steel OSHA Compliant Safety Screen Option
- Base options include self flashing, curb mount and metal building
- 1" Rigid Insulation R7.2
- Full perimeter EPDM bulb gaskets
- Lids open against a 10 PSF live load
- Lid uplift rating 90 PSF
- Hinges and latches 12 GA galvanized steel
- Latches rated for 90 PSF uplift
- UL listed fusible or McCabe resettable links
- Inside and outside manual releases
- High performance gas springs with hold open

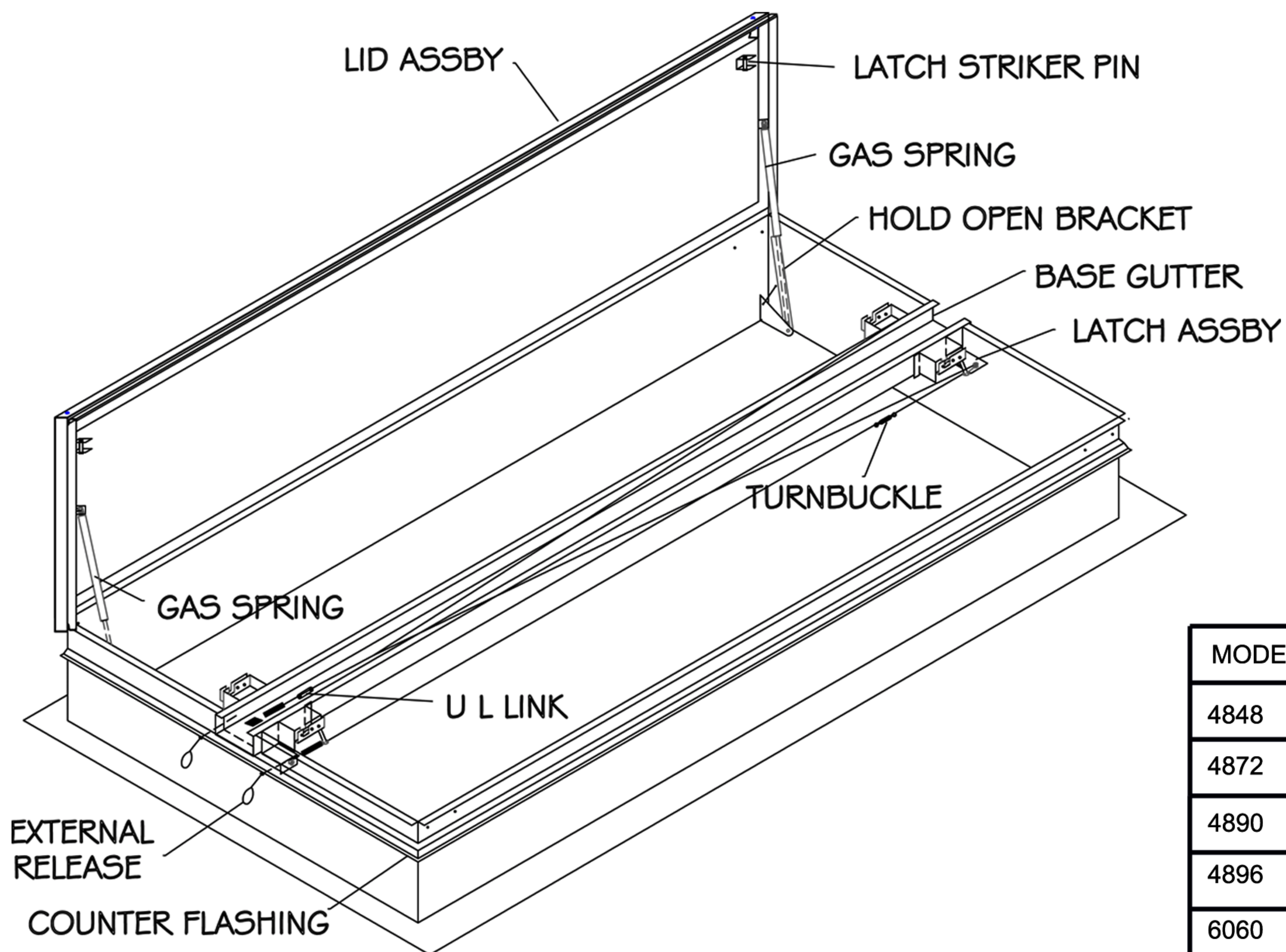
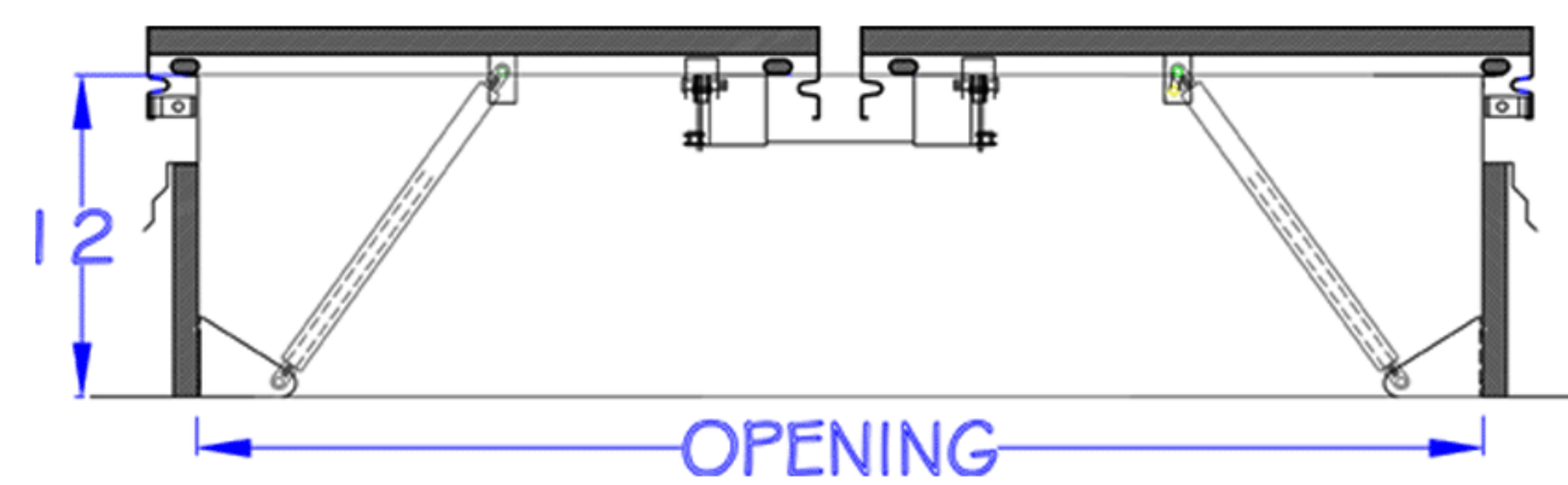
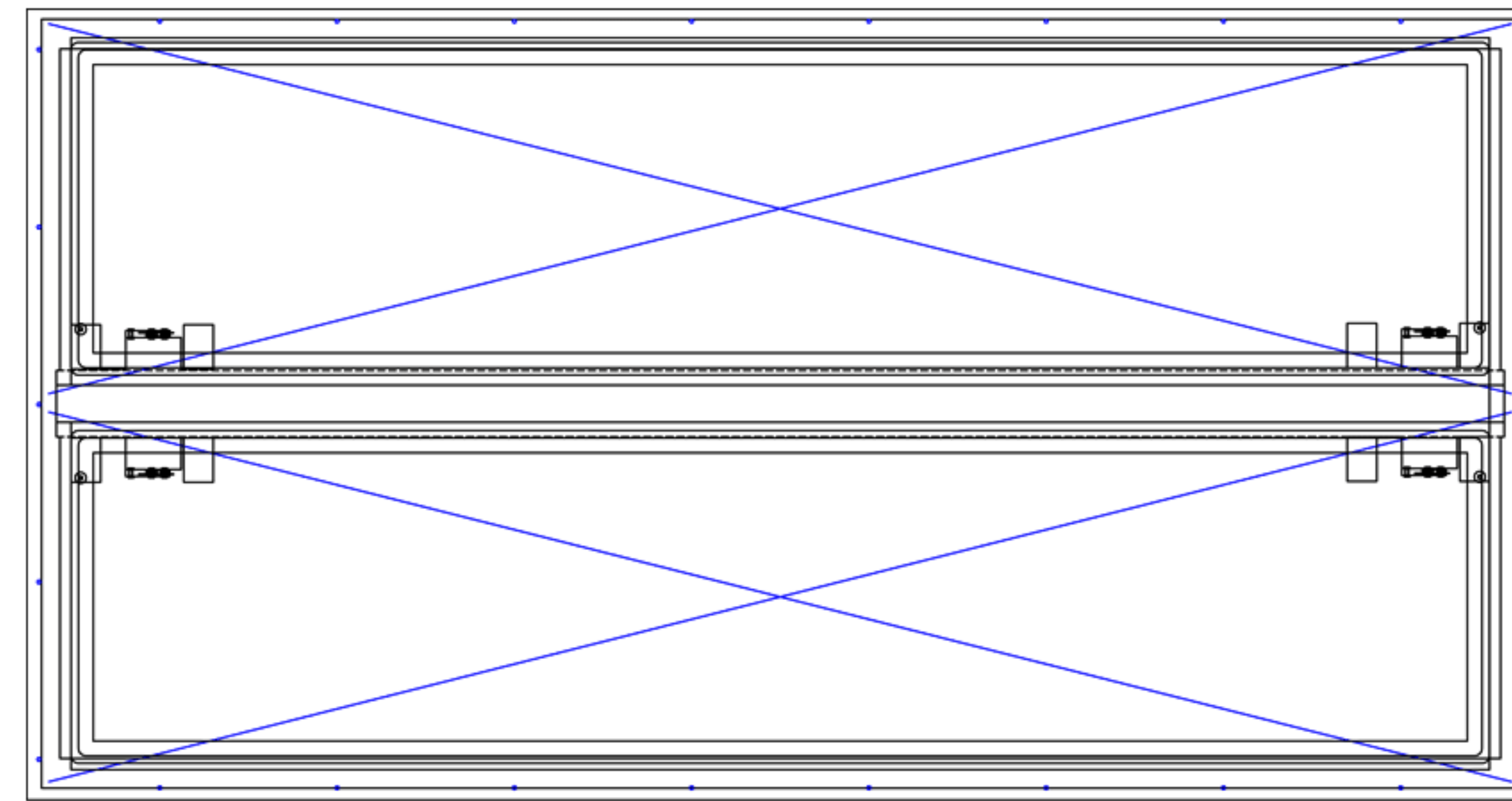

MODEL	SIZE
4848	48" x 48"
4872	48" x 72"
4890	48" x 90"
4896	48" x 96"
6060	60" x 60"
6072	60" x 72"
6090	60" x 90"
6096	60" x 96"



R&S Manufacturing and Sales
 www.RnSales.com
 sales@RnSales.com
 805-375-3980 Fax 805-375-3981

CUSTOMER	QUANTITY
JOB NAME	MODEL
ARCHITECT	DATE

UL LISTED - SOLID LID - HIGH UPLIFT

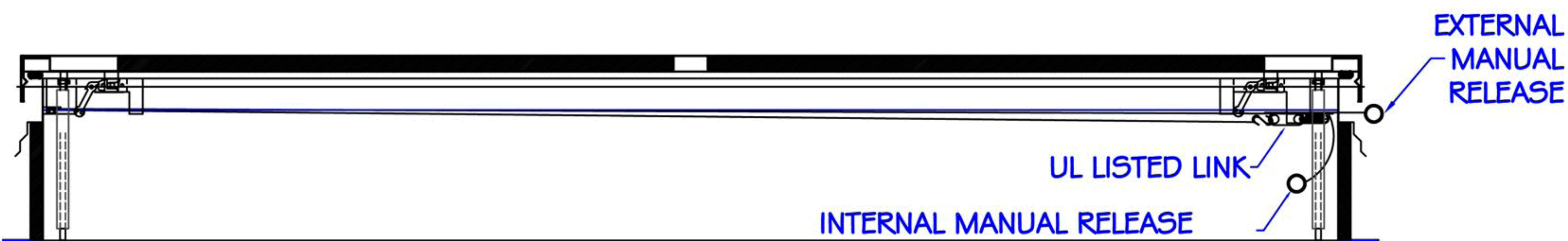
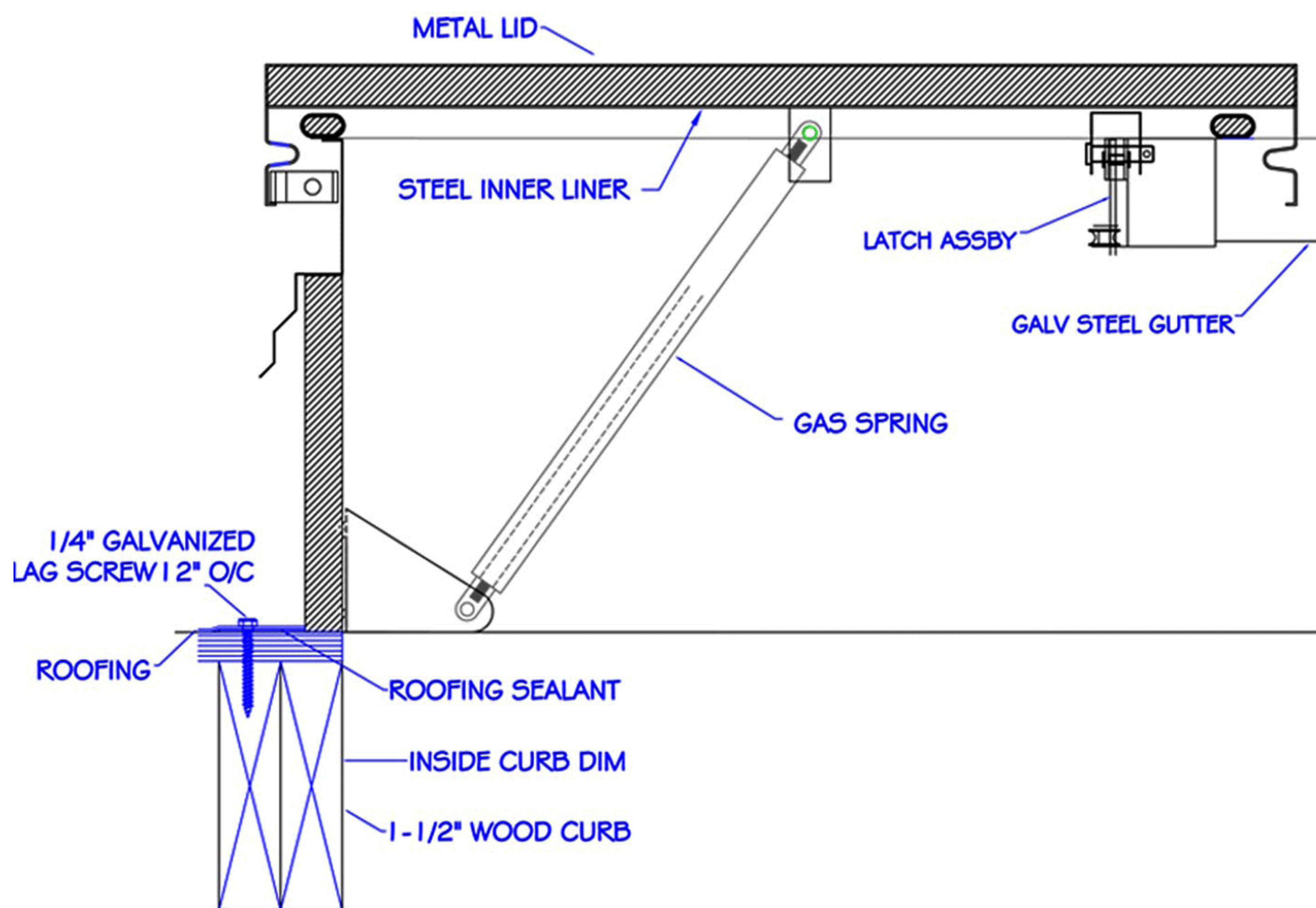
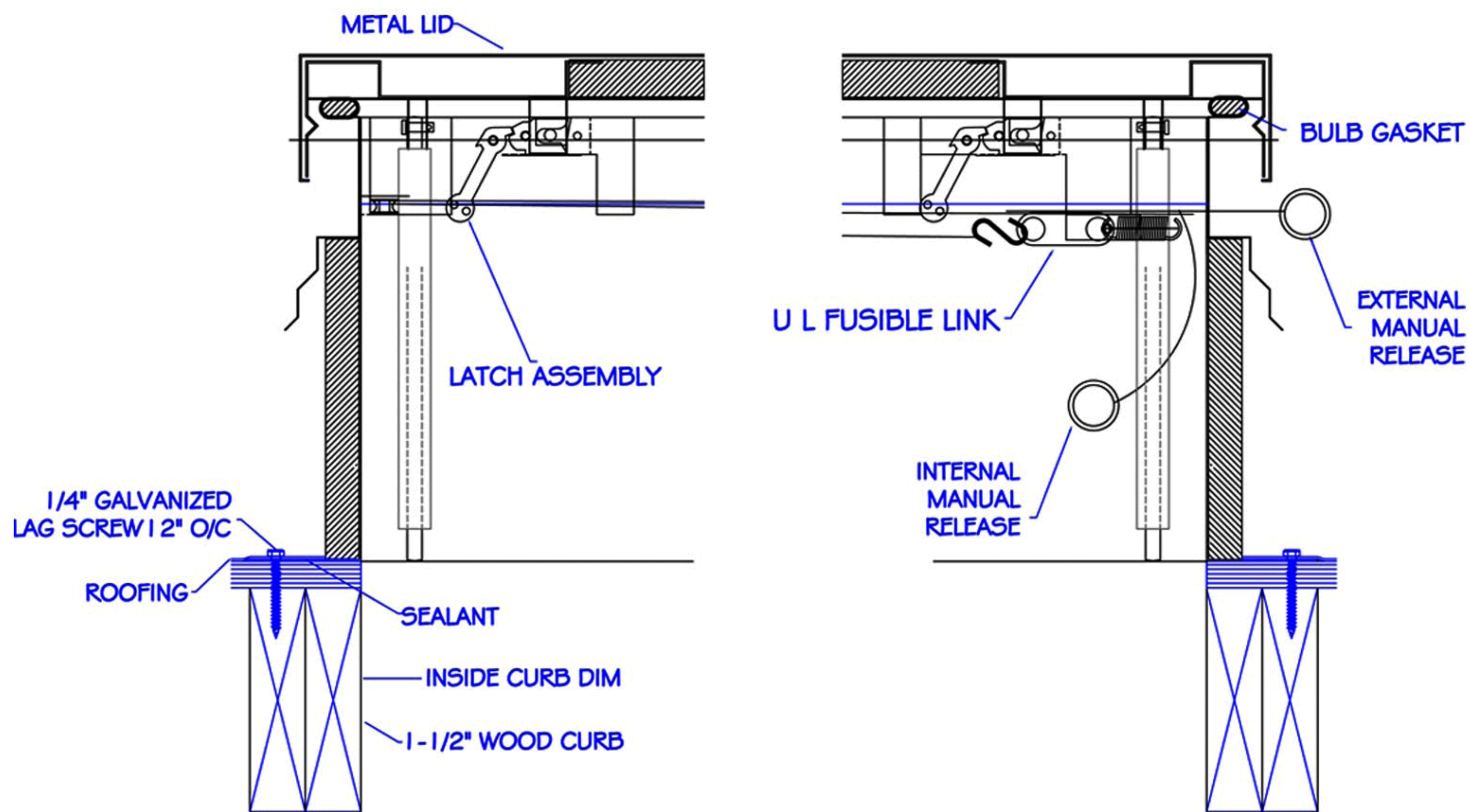

MODEL	SIZE
4848	48" x 48"
4872	48" x 72"
4890	48" x 90"
4896	48" x 96"
6060	60" x 60"
6072	60" x 72"
6090	60" x 90"
6096	60" x 96"



R&S Manufacturing and Sales
 www.RnSales.com
 sales@RnSales.com
 805-375-3980 Fax 805-375-3981

CUSTOMER	QUANTITY
JOB NAME	MODEL
ARCHITECT	DATE

UL LISTED - SOLID LID - HIGH UPLIFT

BASE OPTIONS

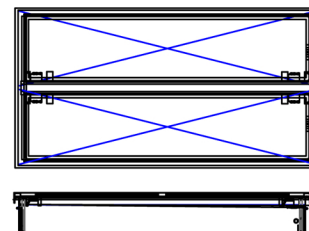
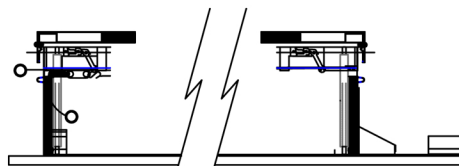
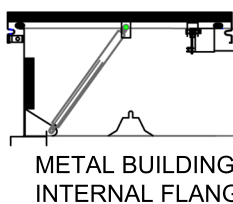
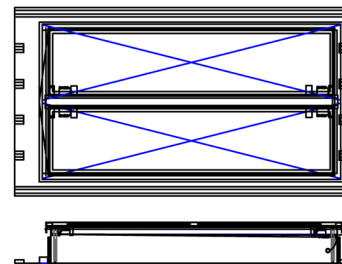
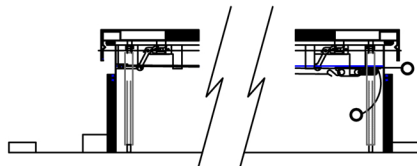
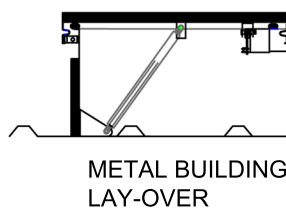
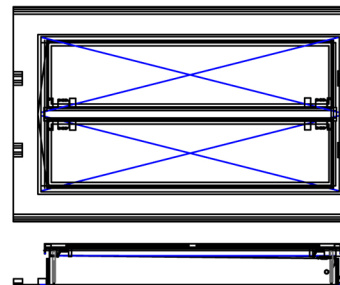
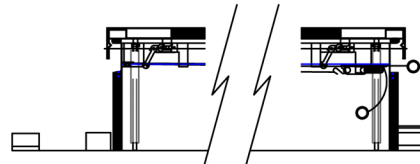
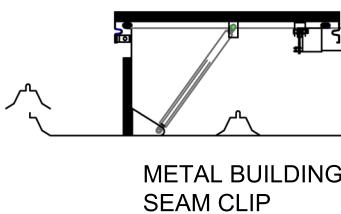
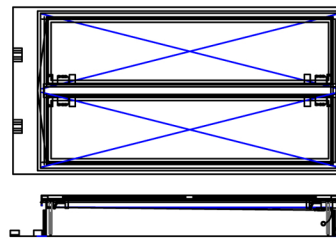
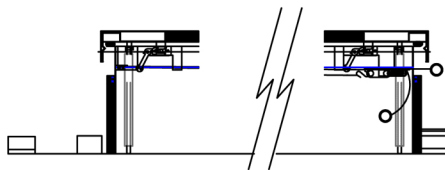
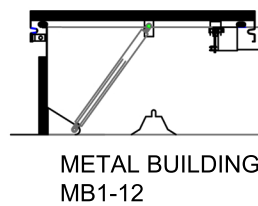
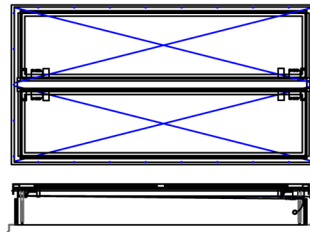
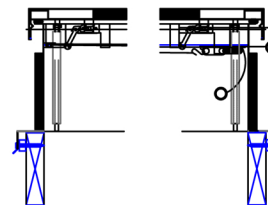
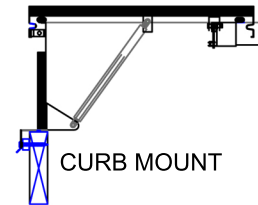
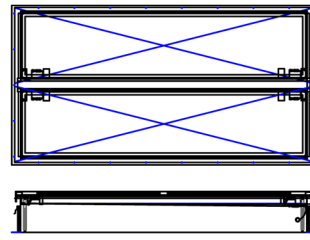
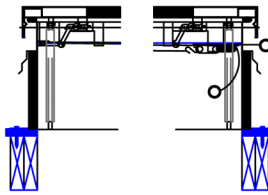
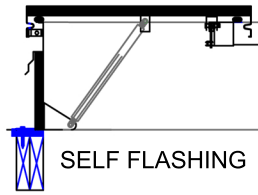

R&S Manufacturing and Sales
www.RnSsales.com
sales@RnSsales.com
 805-375-3980 Fax 805-375-3981

CUSTOMER

QUANTITY

JOB NAME

MODEL

ARCHITECT

DATE